

KFX 210/211/212/213/214 KFC 210/220



Instructions for VELUX control system for smoke ventilation

Contents

Important information	4-5
Contents of packaging	6-7
Overview of printed circuit board	8-9
Break-glass point KFK 100	10
Smoke detector KFA 100	11
Rain sensor KLA 200	12
Ventilation switch KFK 200	13
Motor terminals	14
Wiring	15
Setting of switches	16
Operation of and signals from control unit	17
Back-up batteries	18
Mains connection	19
Status and error indication in control system	20-22
Connected control units	23-28
- Transmit alarm from one control unit KFC to another	23
- Receive and transmit error indications from one control unit KFC to another	24
- Ventilation switch	25
- Rain sensor	26
- Receive alarm from a primary, external control system	27
- Transmit alarms or error indications to other external equipment	28
Replacement of frame in control unit	30
Technical data	31

Important information



Please read instructions carefully before proceeding and keep them for future reference behind the battery holder inside the control unit.

Safety

- Control system for smoke ventilation KFX 210/211/212/213/214 and control unit for smoke ventilation KFC 210/220 can be used by persons (aged 8 years and above) with sufficient experience and knowledge if they have been given instruction concerning their safe use and understand the hazards involved. Cleaning and user maintenance must not be made by unsupervised children.
- Children must not play with the control system.
- The installer must instruct the owner in the function of the control system including resetting of alarms and position of data plate and instructions.
- The data plate is placed in the control unit.
- When resetting alarms, be sure not to touch conductive parts and make sure that no body parts can get caught in the window when reactivated.
- **WARNING!** Make sure to use ESD protection when touching the printed circuit board for example during installation and service.

Product

- The control system has been designed for use with genuine VELUX products. Connection to other products may cause damage or malfunction.
- The control system is in conformity with the Low Voltage Directive and the EMC Directive for use in household, trade, industry and light industry.
- When installed, the control system complies with protection degree IP 42.
- The control system can operate smoke ventilation windows with a total power consumption of 10 A (KFC 210) and 2 x 10 A (KFC 220) respectively.
- Electrical products must be disposed of in conformity with national regulations for electronic waste and not with household waste.
- Used batteries must not be disposed of together with household waste but have to be disposed of in conformity with the relevant national environmental regulations. Batteries contain substances that can be harmful if not handled and recycled correctly.
-  Use local authority battery disposal point where available.
- The packaging can be disposed of with usual household waste.

Installation

- Installation must be carried out by a certified person in accordance with current national regulations.
- The control system must be connected directly to the mains supply in accordance with national regulations. Ensure that the mains supply cannot be disconnected unintentionally. It is recommended that disconnection is only possible using the mains switch or a key switch. At least one of these means for disconnection must be incorporated in the fixed wiring in accordance with national wiring requirements.

Maintenance and service

- Disconnect mains supply and back-up batteries before carrying out any maintenance or service work to the control system and ensure that they cannot be reconnected unintentionally during this time.

Important information



- The control system must be tested after installation, service work and alterations to the system. It must be inspected by qualified personnel at least once a year. Tests and inspections must be documented in accordance with national regulations.
- At the yearly inspection, the connected products must be checked according to their instructions.
- The batteries must be checked at the yearly inspection. If the performance of the batteries is below 50%, they must be replaced. The batteries must be replaced at least every fourth year.
- If you have any technical questions, please contact your VELUX sales company, see telephone list or www.velux.com.

CE Declaration of Conformity According to the Council Directive 2014/35/EU

We herewith declare that the VELUX control systems for smoke ventilation KFX 210 (control unit 3FC F21, smoke detector KFA 100/3FA F01 and break-glass point KFK 100/3FK F00),

KFX 211 (control unit 3FC F21, smoke detector KFA 100/3FA F01 and break-glass point KFK 101/3FK F01),

KFX 212 (control unit 3FC F21, smoke detector KFA 100/3FA F01 and break-glass point KFK 102/3FK F02),

KFX 213 (control unit 3FC F21, smoke detector KFA 100/3FA F01 and break-glass point KFK 103/3FK F03),

KFX 214 (control unit 3FC F21, smoke detector KFA 100/3FA F01 and break-glass point KFK 104/3FK F04) and

VELUX control units for smoke ventilation KFC 210 (3FC F21) and KFC 220 (3FC F22)

- are in conformity with the provisions of Low Voltage Directive 2014/35/EU and EMC Directive 2014/30/EU as amended and
- have been manufactured in accordance with the harmonised standards EN 61000-3-2(2006)+A1(2009)+A2(2009), EN 61000-3-3(2008), EN 55014-1(2006)+A1(2009)+A2(2011), EN 50130-4(2011), EN 60335-1 and EN 62233.

When one of the above-mentioned VELUX control systems or VELUX control units are connected to a VELUX smoke ventilation window GGL -K- ----40, GGU -K- ----40 or CSP, the total system is to be considered as a machine, which is not to be put into service until it has been installed according to instructions and requirements.

The total system then complies with the essential requirements of the Council Directives 2014/35/EU, 2014/30/EU and 2006/42/EC as amended.

The control systems and control units also comply with the Construction Products Regulation (EU) No. 305/2011. For Declaration of Performance, please go to www.velux.com.

VELUX A/S:
(Jens Aksel Thomsen, Test Engineer, Market Approval)

Ådalsvej 99, DK-2970 Hørsholm. 15-02-2015.....

CE DoC 940402-01

Contents of packaging

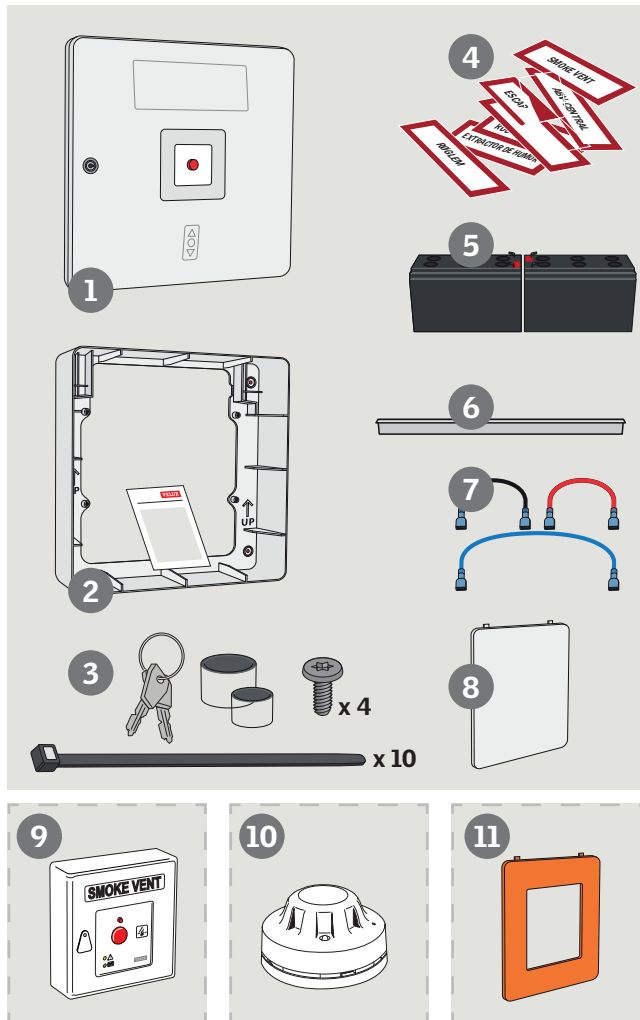

- 1 Control unit for smoke ventilation KFC 210 or KFC 220 – see type designation in the control unit.
 - 2 Frame with instructions
 - 3 Keys, rubber bushes, screws and cable ties
 - 4 Labels
 - 5 Back-up batteries
 - 6 Battery holder
 - 7 Cables for batteries
 - 8 Blank lid
 - 9 Break-glass point KFK 100-104*)
 - 10 Smoke detector KFA 100*)
 - 11 Coloured frame*)
- *) Is delivered depending on type of control system.

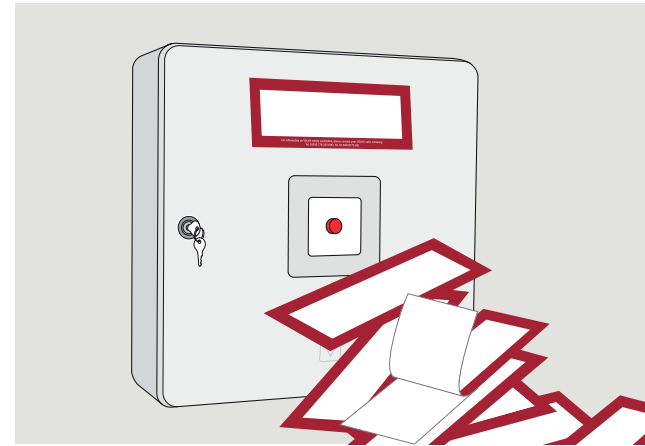

Stick the supplied label "SMOKE VENTILATION" onto the indicated area on the control unit.

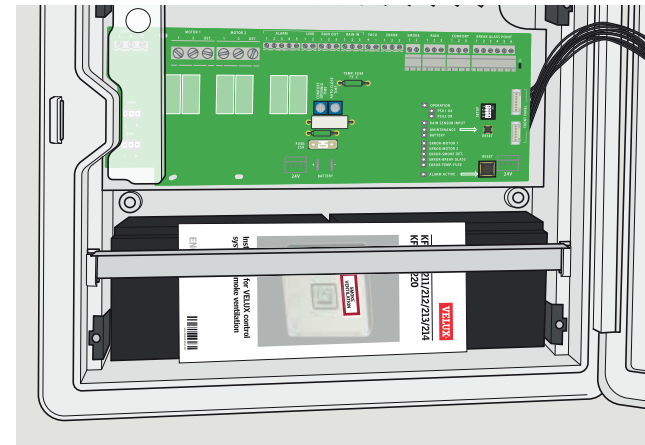

Keep the instructions behind the battery holder in the control unit.

Overview of printed circuit board

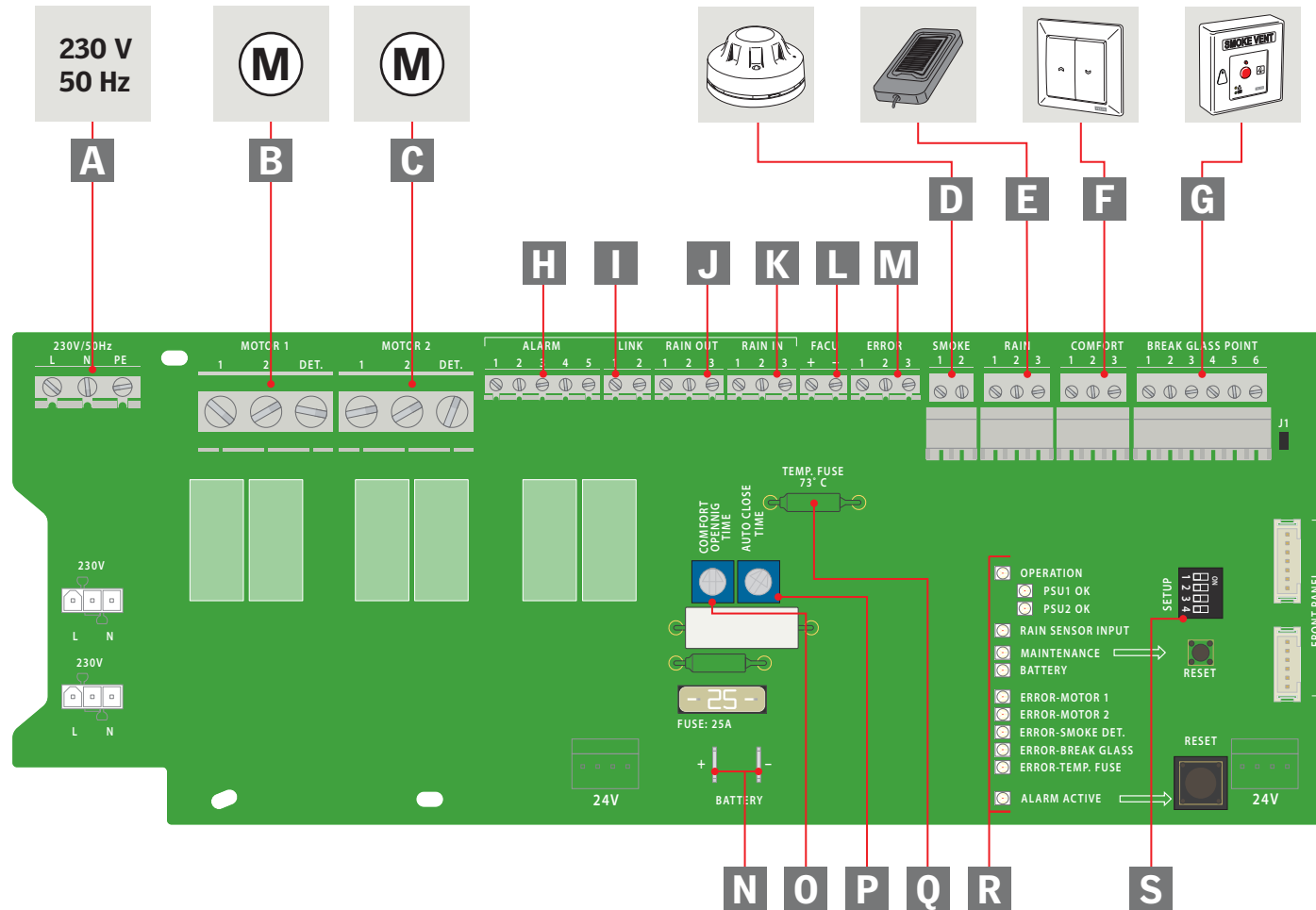

A Mains connection	19	F Ventilation switch	13, 25	K Rain signal - input	26	P Auto close time	13
B Motor 1	14-15	G Break-glass point	10	L FACU terminals	23, 27	Q Temperature fuse	22
C Motor 2	14-15	H Alarm signals	23-24, 27-28	M Error indication	28	R Status indications	20-22
D Smoke detector	11	I Link	24	N Batteries	18	S Setting	16
E Rain sensor	12	J Rain signal - output	26	O Comfort opening time	13		

Break-glass point KFK 100

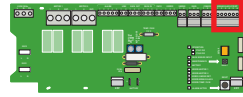

Up to 10 break-glass points can be connected to each control system.

Installation

Break-glass points KFK 100/101/102/103/104 are surface mounted and should be connected in accordance with current national legislation. The installation surface must be smooth and level.

Connection

The break-glass point is connected to the control unit by means of a 6-core cable with a minimum cross-section of 0.5 mm². This cable can be up to 100 m long.

Break-glass points KFK 100/101/102/103/104 must be installed in continuous single line connections to ensure that the complete line from the control unit to the last break-glass point is monitored. Individual connection to more than one break-glass point does not allow for monitoring.

The first additional break-glass point must be connected to the terminals in the control unit. When connecting, lead cable through the rubber membrane and fasten with cable tie.

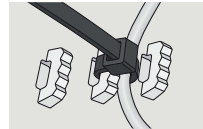
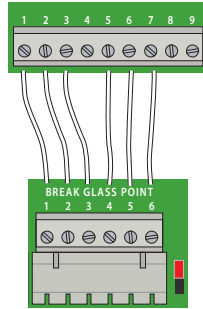

Terminal module J1 (jumper)

Terminal module J1 in the control unit must be moved to the last or only break-glass point – ie to the break-glass point placed farthest away from the control unit. Terminal module J1 in other break-glass points must be removed.

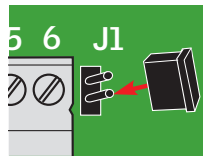

Colour of frame for break-glass point in control unit

The white frame can be replaced by the coloured frame supplied (applies to KFX 211, 212, 213 and 214 and KFC 210 and 220). See page 30.



Smoke detector KFA 100

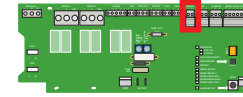
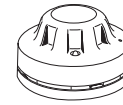

Up to 10 smoke detectors can be connected to each control system.

Installation

Smoke detector KFA 100 should always be fitted on the ceiling in accordance with current national legislation. After fitting the base, the smoke detector can be snapped into place. Position dust cover over the smoke detector until it is ready for operation.

Connection

The smoke detector is connected to the control unit by means of a 2-core cable with a minimum cross-section of 0.5 mm². This cable can be up to 100 m long.

Smoke detectors KFA 100 must be installed in continuous single line connections to ensure that the complete line from the control unit to the last detector is monitored. Individual connection to more than one break-glass point does not allow for monitoring.

When connecting, lead cable through the rubber membrane and fasten with cable tie.

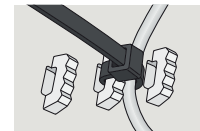
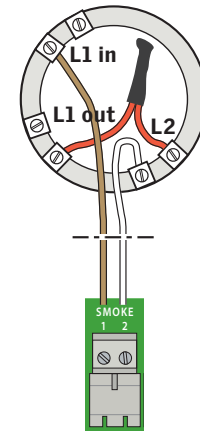

Terminal module in control system

The terminal module in the control unit must be moved to the last or only smoke detector – ie to the smoke detector placed farthest away from the control unit.

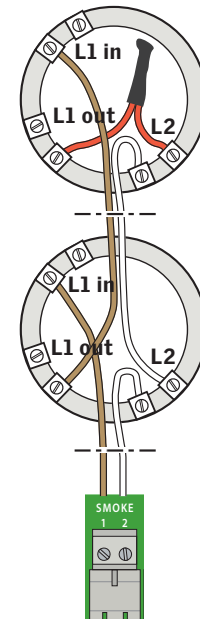

Rain sensor KLA 200

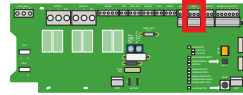

The product can be purchased separately.

Connection

The rain sensor is connected to the control unit by means of a 3-core cable with a minimum cross-section of 0.5 mm². This cable can be up to 100 m long.

Note: If the rain sensor has been activated, ie has closed the window due to rain, it will take at least 2 minutes before the comfort ventilation can be activated again.

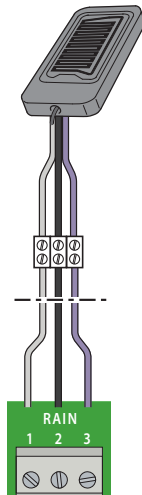

When connecting, lead cable through the rubber membrane and fasten with cable tie.

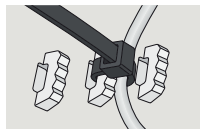

Ventilation switch KFK 200

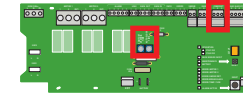

Up to 10 ventilation switches can be connected to each control system.

The product can be purchased separately.

Connection

The ventilation switch is connected to the control unit by means of a 3-core cable with a minimum cross-section of 0.5 mm². This cable can be up to 100 m long.

Output 1: Open

Output 2: Close

Output 3: Common

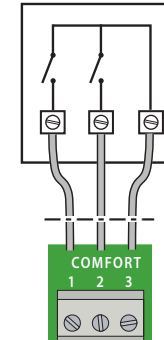

When connecting, lead cable through the rubber membrane and fasten with cable tie.

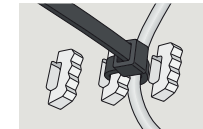

Setting of timers

COMFORT OPENING TIME

The time taken for the window to open (in seconds) can be set when the window is opened for comfort ventilation purposes (factory setting is about 14 seconds).

Note: The window must not be opened more than 20 cm.

Min duration: 5 seconds

Max duration: 60 seconds

AUTO CLOSE TIME

Automatic closing of windows opened for comfort ventilation purposes can also be set. This function is only active if switch 4 is set in position ON (see page 16).

Min opening time: 2 minutes

Max opening time: 60 minutes

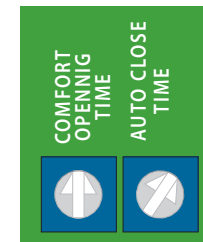

Motor terminals

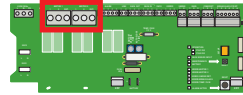

Each terminal is intended for 24 V DC and max 10 A.

Control unit KFC 210 (10 A)

In this example, only motor terminal **1** is active.

Max **4** smoke ventilation windows
GGL/GGU -K-- ----40

or

1 smoke ventilation window **CSP** can be connected to the control unit.

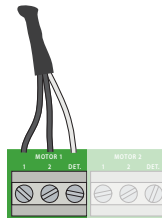

Control unit KFC 220 (2 x 10 A)

In this example, both motor terminals **1** and **2** are active.

Max **8** smoke ventilation windows
GGL/GGU -K-- ----40 (max 4 windows per motor terminal)

or

2 smoke ventilation windows **CSP** can be connected to the control unit.

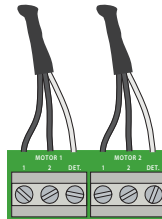

Terminal module

To ensure cable monitoring, the terminal module in the control unit must be moved to the last connection between smoke ventilation windows GGL/GGU -K-- ----40 or CSP and the cables from the control unit.

NB: In case motors operate in the wrong direction, transpose the two motor cables in the terminal.

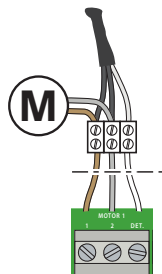
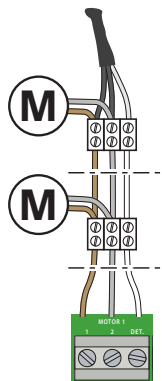

Wiring

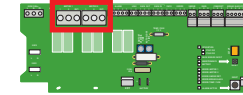

Electrical cables should be drawn according to regulations by qualified personnel. The control system and its cables should be installed in compliance with current national legislation and the requirements of local authorities.

Maximum cable length/prescribed cross-sectional size of cables

The maximum allowed cable lengths between control unit and motor and the prescribed cross sectional sizes of the cables are given in the table below. The cable must be protected according to National/European Standards.

Calculation of max. cable length: $56 \times A/I$

A is cable cross-section and **I** is max motor current in total.

Allowed maximum voltage drop in the cable: 2 V

Operation current: The total of all motor currents.

Cable cross-section per motor terminal for smoke ventilation window **GGL/GGU -K-- ----40**

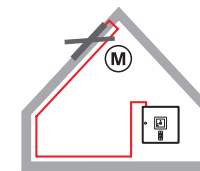

Cable cross-section	Max. cable length for number of motors (M *)			
	M 1	M 2	M 3	M 4
3 x 1.5 mm ²	42 m	21 m	14 m	10 m
* 5 x 1.5 mm ²	84 m	42 m	28 m	21 m
3 x 2.5 mm ²	70 m	35 m	23 m	17 m
* 5 x 2.5 mm ²	140 m	70 m	46 m	35 m
3 x 4 mm ²	112 m	56 m	37 m	28 m
3 x 6 mm ²	168 m	84 m	56 m	42 m

*) 2x2 conductors in parallel

Cable cross-section per motor terminal for smoke ventilation window **CSP**

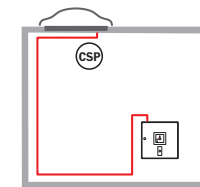

Cable cross-section	Max. cable length *)
3 x 1.5 mm ²	8 m
* 5 x 1.5 mm ²	17 m
3 x 2.5 mm ²	14 m
* 5 x 2.5 mm ²	28 m
3 x 4 mm ²	22 m
3 x 6 mm ²	33 m

*) 2x2 conductors in parallel

Only one smoke ventilation window CSP per motor terminal

Setting of switches

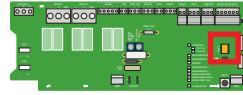

Switch 1

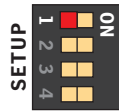

Cable errors are indicated by the yellow light-emitting diode that flashes on and off and an acoustic alarm from control unit and connected break-glass points.
(Factory setting).

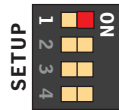

Cable errors are indicated by the red light-emitting diode and an acoustic alarm from control unit and connected break-glass points, and windows open.

Switch 2

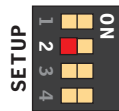

No external fire alarm is connected to FACU terminal (FACU = Fire Alarm Control Unit).
(Factory setting).

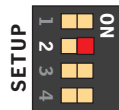

An external fire alarm is connected to FACU terminal and the cable connection is monitored.

Switch 3

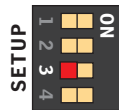

If an alarm is activated via a smoke detector, the window opens fully.
(Factory setting).

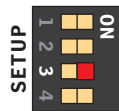

If an alarm is activated via a smoke detector, all windows that are open (in comfort ventilation position) close.

Note: If an alarm is activated via a break-glass point, all windows open.

Switch 4

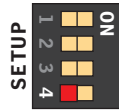

Automatic, time controlled closing of comfort ventilation is off.
(Factory setting).

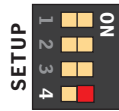

Automatic, time controlled closing of comfort ventilation is on.

The time is set by means of the timer "AUTO CLOSE TIME", see section *Ventilation switch KFK 200*.

Operation of and signals from control unit

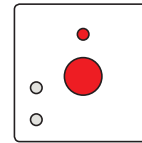
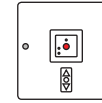

Break-glass point

In case of fire: Break the glass cover and press the red button. All windows connected to the control system open. The red light-emitting diode over the red button in the control unit is on and an acoustic alarm sounds. All ventilation and rain sensor functions are disengaged.

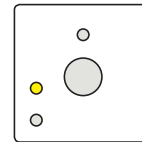

Yellow light-emitting diode

In case of system errors, the yellow light-emitting diode flashes on and off and an acoustic alarm sounds. Error indication occurs, if cables for motors, break-glass points or smoke detectors are interrupted or short-circuited, or if the batteries are defective. If additional break-glass points are connected, the corresponding diodes in these will also flash on and off and an acoustic alarm sounds.

Additional information on error causes can be seen on the printed circuit board in the control unit. See section *Status and error indications in control system*.

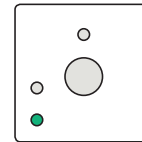

Green light-emitting diode

Under normal operation conditions, the green light-emitting diode in the control unit is on. All other light-emitting diodes are off. If additional break-glass points are connected, the corresponding diodes in these will also be on.

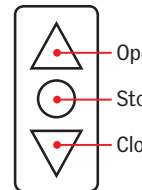

Operating buttons for comfort ventilation

A short press of the top ventilation button opens the window to max comfort ventilation position.

A short press of the bottom ventilation button closes the window completely.

By pressing and holding the top or bottom ventilation button, the window opens/closes until the button is released.

By pressing the stop button or by pressing the top and bottom buttons simultaneously, the window stops.

By means of the timers in the control unit it is possible to set the duration of the opening when the window is opened for comfort ventilation and set automatic closing of the window. See section *Ventilation switch KFK 200*.

NB: If a rain sensor is fitted, the comfort ventilation function will automatically be blocked if rain is detected.

Back-up batteries

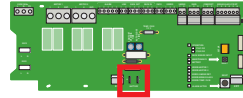

The control unit has batteries that ensure emergency power supply for 72 hours in case of power failure. Therefore, if there is a fire alarm within these 72 hours, the windows will still be able to open.

Note: The batteries must be checked at the yearly inspection. If performance of the batteries is below 50%, they must be replaced. The batteries must be replaced at least every fourth year.

Note the replacement date.

In case of power failure, the comfort ventilation is interrupted automatically, and all windows close after 2 minutes. Comfort ventilation is not possible until the mains connection has been re-established.

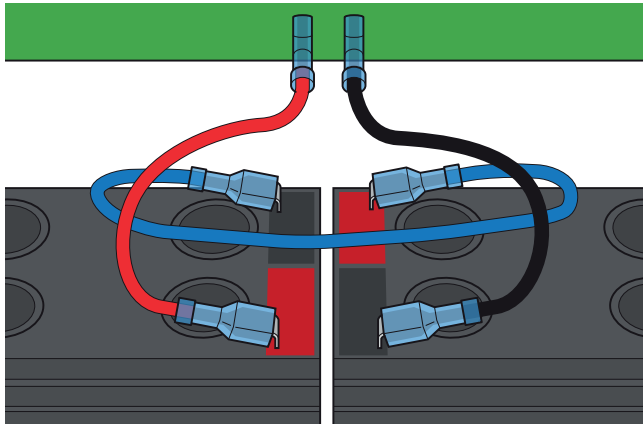

Install battery holder.

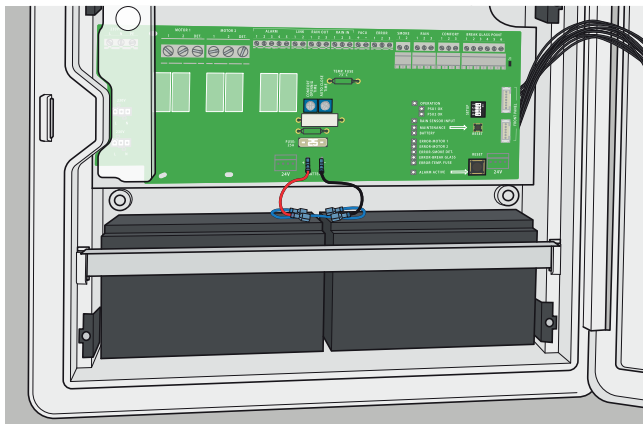

Mains connection

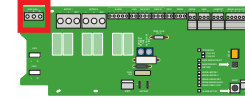

Remove cover plate over the terminals and connect the cable.

⚠ Take all necessary actions to comply with current local requirements (contact a qualified electrician, if necessary).

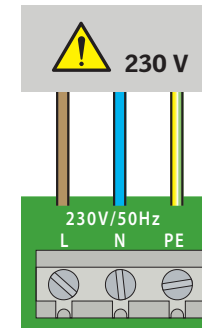

Lead cable as shown and fasten it in cable gland. For optimum fixing, the rubber bush can be replaced by one of the rubber bushes supplied.

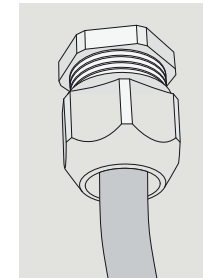

Status and error indication in control system

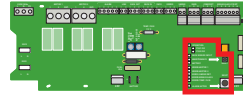

OPERATION

The printed circuit board monitors the present status of the control system.

Normal operation condition of the control unit is indicated with a green light emitting diode.

PSU1 OK

The printed circuit board monitors the present status of the power supply for motor terminal 1 (used in control units KFC 210 and KFC 220).

The light-emitting diode indicates that the motor terminal is being supplied with power from the integrated power supply.

If the 230 V mains supply to the control unit is interrupted, the printed circuit board automatically switches to battery supply and the diode is turned off.

PSU2 OK

The printed circuit board monitors the present status of the power supply for motor terminal 2 (used in control units KFC 220 only).

The light-emitting diode indicates that the motor terminal is being supplied with power from the integrated power supply.

If the 230 V mains supply to the control unit is interrupted, the printed circuit board automatically switches to battery supply and the diode is turned off.

RAIN SENSOR - INPUT

The printed circuit board monitors the present status of the rain sensor.

If the connected rain sensor detects rain, the yellow light-emitting diode is on and any window opened for comfort ventilation closes. When the rain has stopped, the yellow light-emitting diode is turned off and the window can be opened for comfort ventilation again after two minutes.

MAINTENANCE

The printed circuit board monitors the time between inspection periods. If more than 15 months have passed since the last inspection, the yellow light-emitting diode is on and an acoustic alarm sounds. During the inspection, the system is reset by pressing the button at the right  for at least 5 seconds. After this, 15 months will pass before the light-emitting diode comes on again, if the service time is exceeded. Exceeded service intervals are also error indicated with a yellow light-emitting diode in the integrated break-glass point and possible additional break-glass points and an acoustic alarm.

Status and error indication in control system

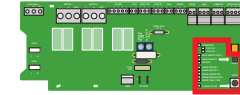

BATTERY

The printed circuit board monitors the status of the back-up batteries. If the control unit is supplied with power from the back-up batteries, the yellow light-emitting diode flashes on and off showing that the 230 V mains supply is interrupted.

If the batteries are not connected or defective, the yellow light-emitting diode is on permanently showing that the batteries should be connected or replaced. This is also the case if the 25 A fuse is defective. In all three cases, an acoustic alarm sounds.

Note: If the back-up batteries are heavily discharged, the yellow light-emitting diode flashes on and off and the green OPERATION diode on the circuit board is on until the batteries are fully charged.

ERROR - MOTOR 1

The printed circuit board monitors for defects in the cable from motor terminal 1 (used in control units KFC 210 and KFC 220).

If the cable is interrupted, the yellow light-emitting diode flashes on and off. If the cable is short-circuited, the yellow light-emitting diode is on permanently.

The error is also indicated in the integrated break-glass point and possible additional break-glass points.

ERROR - MOTOR 2

The printed circuit board monitors for defects in the cable from motor terminal 2 (used in control unit KFC 220 only).

If the cable is interrupted, the yellow light-emitting diode flashes on and off. If the cable is short-circuited, the yellow light-emitting diode is on permanently.

The error is also indicated in the integrated break-glass point and possible additional break-glass points.

ERROR - SMOKE DETECTOR

The printed circuit board monitors for defects in the cable to any smoke detectors that are connected.

If the cable to the connected smoke detector(s) is interrupted, the yellow light-emitting diode flashes on and off. If the cable is short-circuited, the yellow light-emitting diode is on permanently.

The error is also indicated in the integrated break-glass point and possible additional break-glass points.

Status and error indication in control system

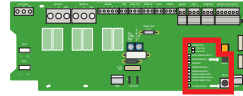

ERROR - BREAK-GLASS POINT

The printed circuit board monitors for defects in the cable to any break-glass points that are connected.

If the cable to the connected break-glass point(s) is interrupted, the yellow light-emitting diode flashes on and off. If the cable is short-circuited, the yellow light-emitting diode is on permanently.

The error is also indicated in the integrated break-glass point and possible additional break-glass points.

ERROR - TEMP. FUSE

The printed circuit board monitors the temperature in the control unit.

If the temperature in the control unit rises above 70 °C, the temperature fuse on the printed circuit board is activated and all connected windows open for smoke ventilation. The yellow light-emitting diode is on permanently until the printed circuit board has been replaced. After replacing the printed circuit board, the installation must be service tested thoroughly to ensure that the system works correctly.

The error is also indicated in the integrated break-glass point and possible additional break-glass points.

ALARM - ACTIVE

The red light-emitting diode on the front of the control unit is on permanently when the smoke ventilation function has been activated (from break-glass point, smoke detector or external fire alarm).

The alarm can be reset by pressing the button  at the right. After this, the light-emitting diode on the printed circuit board and in all break-glass points are turned off.

Connected control units

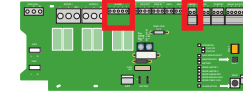

Transmit alarm from one KFC control unit to another

In installations with several connected control units, all smoke detectors and additional break-glass points must be connected to control unit 1 only (see below). In the other control units, the glass plate on the front face must be replaced by the blank lid provided. In case of an alarm, an acoustic alarm sounds from all control units and all windows open.

Connection is established from the ALARM terminal in the principal control unit to the FACU terminal in the next control unit. If more than two control units are linked, connect from the ALARM terminal in control unit 2 to the FACU terminal in control unit 3 etc.

Note: In control unit 2 and possible additional control units, dip switch no. 2 is set in position ON.

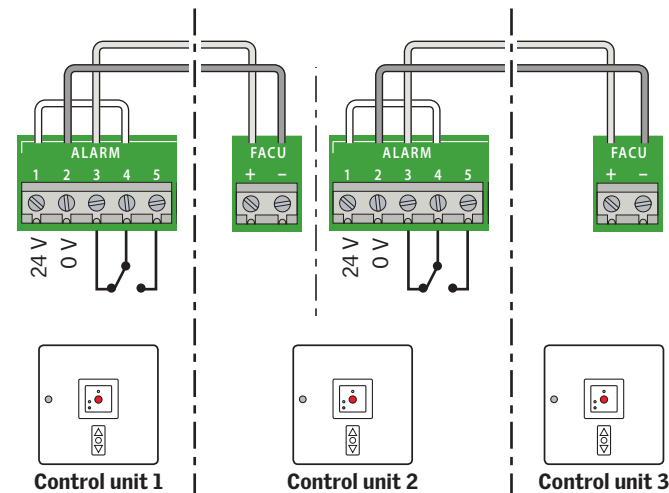

Connected control units

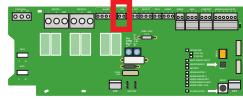

Receive and transmit error indications from one control unit KFC to another

Up to 10 control units can be connected.

In the connection shown below, error indications in one control unit will be registered and shown in all control units. Indication of the specific error can be seen on the printed circuit board of the control unit where the error has occurred.

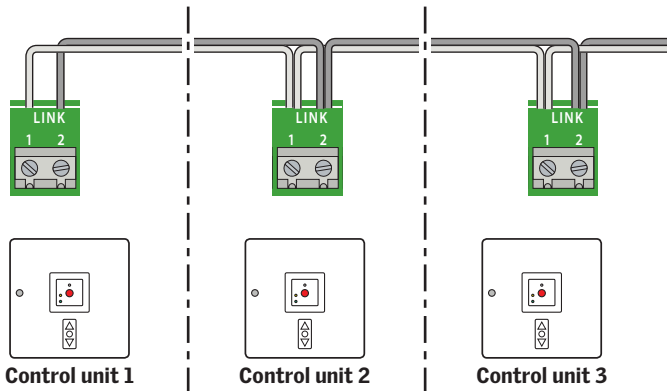

Connected control units

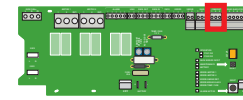

Ventilation switch

Up to 10 ventilation switches KFK 200 can be connected to each control system. Up to 10 control systems can be connected.

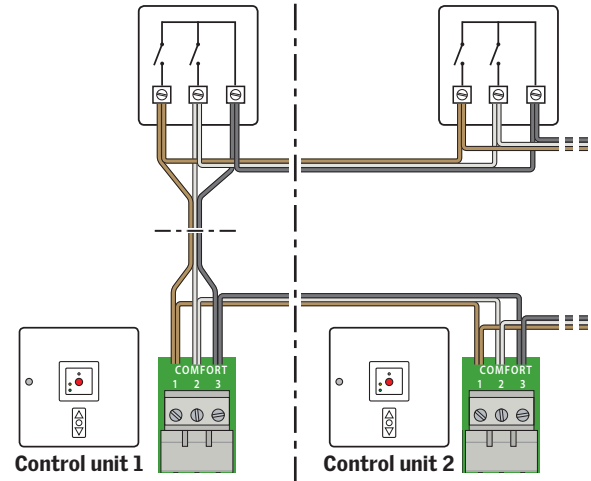

Note: Do **not** connect the control systems if you would like a local ventilation switch.

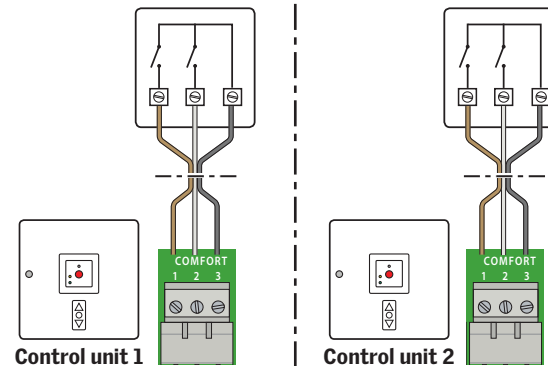

Connected control units

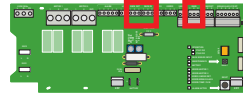

Rain sensor

The product can be purchased separately.

Connection

The rain sensor is connected to the control system by means of a 3-core cable with a minimum cross-section of 0.5 mm². This cable can be up to 100 m long.

NB: If the rain sensor has been activated, it will take at least 2 minutes before the comfort ventilation can be activated again.

The example below shows a cable connection with several control systems but only one rain sensor.

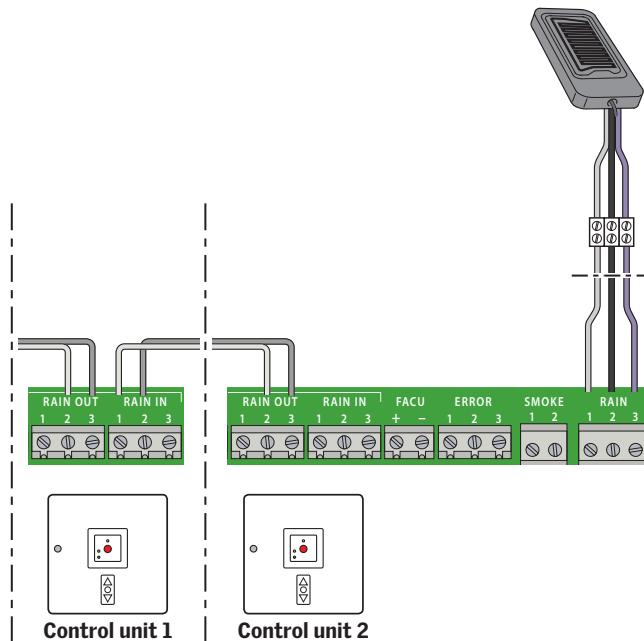

Connected control units

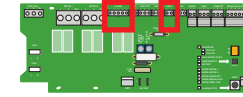

Receive alarm from a primary, external control system

In installations with several connected control systems, all smoke detectors and additional break-glass points must be connected to the primary, external control system according to the instructions supplied with them. In this installation, control unit KFC is controlled by the primary, external control system and the smoke ventilation function will be activated, when an alarm is received from the primary, external control system.

Connection is established by placing the cable from the primary control system in the FACU-terminal in control unit KFC.

Note: Set dip switch no. 2 in position ON in the control unit.

To ensure monitoring of cables, one of the following descriptions must be followed:

- a** If the external control system has a 24 V DC or 48 V DC outlet which is interrupted in case of fire,
- b** If the external control system has one potential-free relay outlet only which is interrupted in case of fire,

monitoring of cables is obtained by connecting 24 V DC or 48 V DC through the relay.

Note: Do not overload the 24 V outlet with other additional connections.

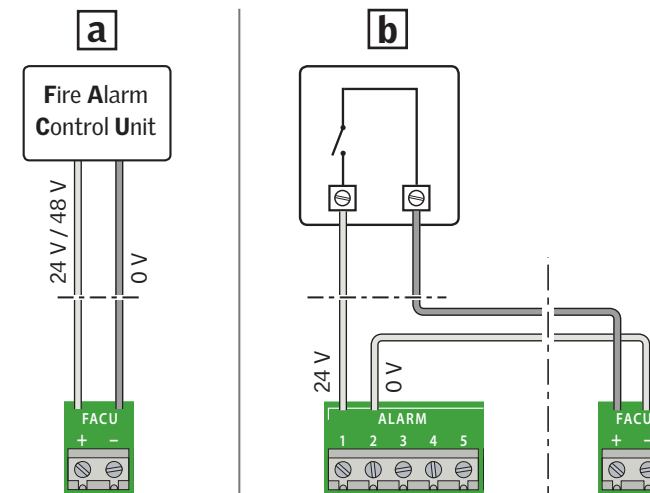

Connected control units

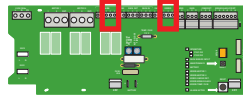

Transmit alarms or error indications to other external equipment

It is possible to transmit an alarm or an error indication to other external equipment.

- a) An alarm will be transmitted from the ALARM terminal where a potential-free relay switches in case of alarm.
- b) Error indications will be transmitted from the ERROR terminal where a potential-free relay switches in case of alarm.

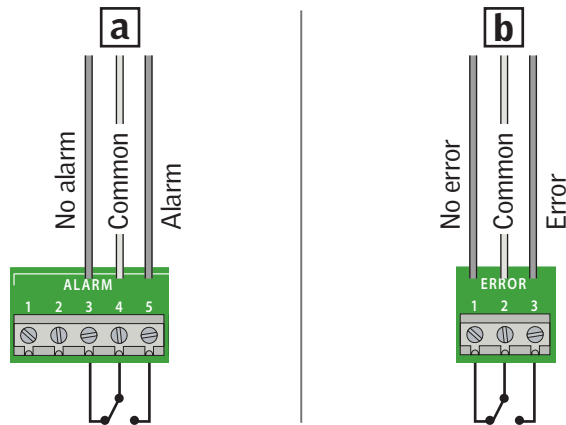

Replacement of frame in control unit

The white frame of the control unit can be replaced by the coloured frame supplied (applies to KFX 211, 212, 213 and 214 only).

Remove white frame as shown.

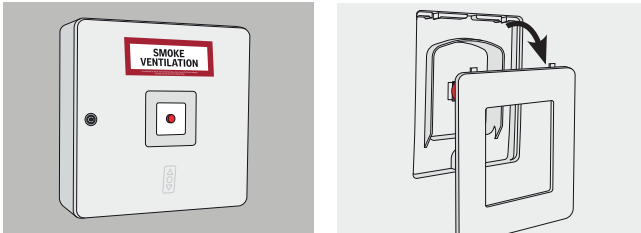
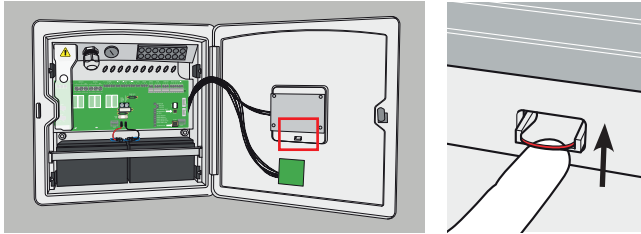

Place glass from the white frame in the coloured frame.

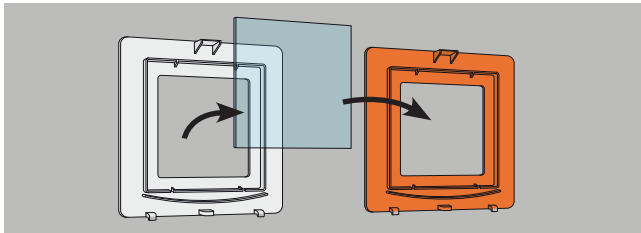

Fit the coloured frame.

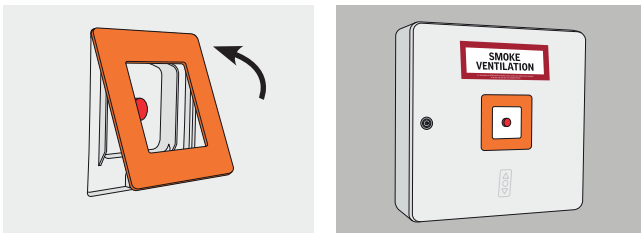

Technical data

Primary voltage: 230 V AC/50 Hz (±10%)

Power consumption:

- KFC 210 max 250 W
- KFC 220 max 500 W

Secondary voltage: 24 V DC (21-26.4 V DC)

Ripple voltage: max 2 Vpp

Load max.:

- 10 A (KFC 210)
- 2 x 10 A (KFC 220)
- ED 10% per 10 minutes

Alarm and error relays: Contact rating 24 V DC, 1 A

Battery backup:

- 2 x 12 V/7.2 A h
- Expected battery lifetime: 4 years

Interruption time between mains supply and batteries: Max 2.5 sec

Fuses:

- Battery fuse 25 A
- Thermo fuse 73°C

Status LED in break-glass point:

- Green light, system OK
- Yellow light, error. For details, see page 15 and 18-20
- Red light, alarm active

Environmental class: 1

Operational temperature: -5°C to +40°C

IP rating: IP 42

Cabinet size for wall mounting: 398 x 393 x 127 mm (W x H x D)

Mounting hole size for flush mounting:

- 355 (±5) x 355 (±5) x 100 mm (W x H x D)
- Wall thickness min 10 mm

Weight KFC 210:

- Without batteries: 3.1 kg
- With batteries: 8.0 kg

Weight KFC 220:

- Without batteries: 3.7 kg
- With batteries: 8.6 kg

Cabinet colour: RAL 9016, white

Maintenance: Once a year or according to local requirements (service timer 15 months)

AR: VELUX Argentina S.A. 348 4 639944	HU: VELUX Magyarország Kft. (06/1) 436-0601
AT: VELUX Österreich GmbH 02245/32 3 50	IE: VELUX Company Ltd. 01 848 8775
AU: VELUX Australia Pty. Ltd. 1300 859 856	IT: VELUX Italia s.p.a. 045/6173666
BA: VELUX Bosna i Hercegovina d.o.o. 033/626 493, 626 494	JP: VELUX-Japan Ltd. 0570-00-8145
BE: VELUX Belgium (010) 42.09.09	LT: VELUX Lietuva, UAB (85) 270 91 01
BG: VELUX Bulgaria EOOD 02/955 99 30	LV: VELUX Latvia SIA 67 27 77 33
BY: FE VELUX Roof Windows (017) 217 7385	NL: VELUX Nederland B.V. 030 - 6 629 629
CA: VELUX Canada Inc. 1 800 88-VELUX (888-3589)	NO: VELUX Norge AS 22 51 06 00
CH: VELUX Schweiz AG 062 289 44 45	NZ: VELUX New Zealand Ltd. 0800 650 445
CL: VELUX Chile Limitada 2 953 6789	PL: VELUX Polska Sp. z o.o. (022) 33 77 000 / 33 77 070
CN: VELUX (CHINA) CO. LTD. 0316-607 27 27	PT: VELUX Portugal, Lda 21 880 00 60
CZ: VELUX Česká republika, s.r.o. 531 015 511	RO: VELUX România S.R.L. 0-8008-83589
DE: VELUX Deutschland GmbH 01806 / 33 33 99 Festnetz: 0,20 €/Anruf Mobilfunk: max. 0,60 €/Anruf	RS: VELUX Srbija d.o.o. 011 20 57 500
DK: VELUX Danmark A/S 45 16 45 16	RU: ZAO VELUX 8 800 200 7520
EE: VELUX Eesti OÜ 621 7790	SE: VELUX Svenska AB 042/20 83 80
ES: VELUX Spain, S.A. 91 509 71 00	SI: VELUX Slovenija d.o.o. 01 724 68 68
FI: VELUX Suomi Oy 0207 290 800	SK: VELUX Slovensko, s.r.o. (02) 33 000 555
FR: VELUX France 0821 02 15 15 0,119€ TTC/min	TR: VELUX Çatı Pencereleri Ticaret Limited Şirketi 0 216 302 54 10
GB: VELUX Company Ltd. 01592 778 225	UA: VELUX Ukraina TOV (044) 2916070
HR: VELUX Hrvatska d.o.o. 01/5555 444	US: VELUX America Inc. 1-800-88-VELUX